

TM2

processador de alimentos



YouTube

- Construídos em alumínio anodizado e aço inox.
- Motor ventilado para uso contínuo.
- Design compacto para um melhor aproveitamento dos espaços na cozinha.
- Exclusivo sistema de queda direta do alimento no equipamento, que permite trabalhar com alimentos macios e delicados, como a mussarela e outros queijos.
- Segurança garantida por 3 micro interruptores: na alavanca, na tampa e na cuba.
- Cubo de coleta de alimentos com sistema de segurança.
- Disponível com tampa em inox lavável na lava-louças
- Ampla gama de discos disponíveis para inúmeras aplicações.



Discos fatias DF

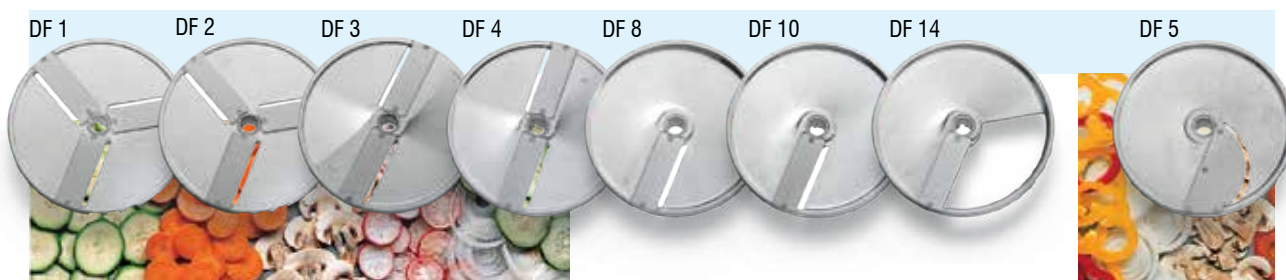

Discos bastões DQ / Discos bastões DQ



Discos cubos PS



Discos para desfiar DT

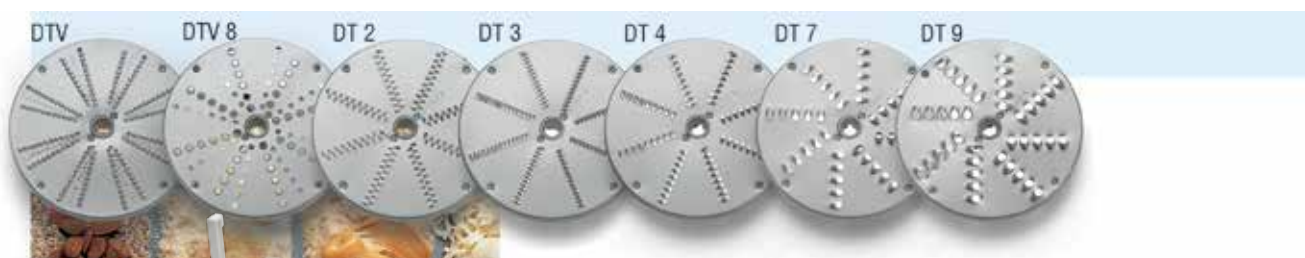

Tampa com abertura lateral.



Tubo para descarga continua, com interruptor de segurança.

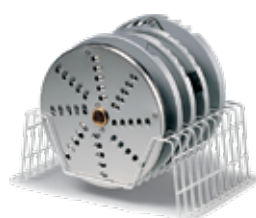

Porta Discos



Limpador para discos PS

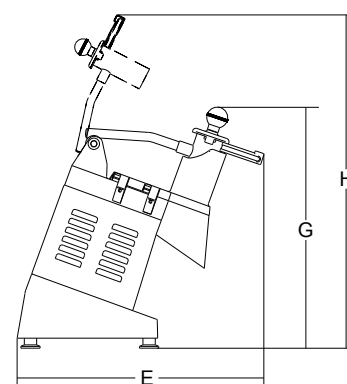
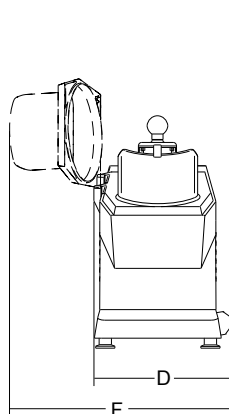
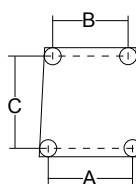
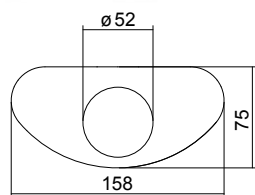

	watt/HP	1ph/3ph	r.p.m.	mm	mm	mm	mm	mm	mm	mm	mm	kg	mm	kg
TM Inox	515/0.7	1ph/3ph	300	225	195	255	280	510	400	510	770	18.5	720x350x500	22
TM All	515/0.7	1ph/3ph	300	225	195	255	280	510	400	510	770	18.5	720x350x500	22