

SIGIX M20









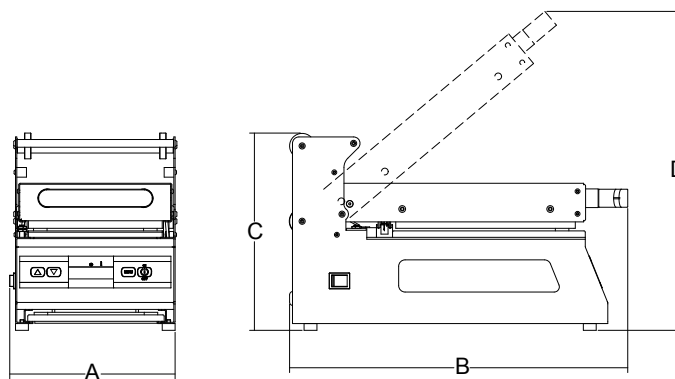

seladora manual para bandejas plásticas

- Prática e robusta embaladora manual.
- Estrutura em aço inox AISI 304
- Controle eletrônico de temperatura e pré-aquecimento
- Contador de números de embalagens seladas
- Soldagem em 4 segundos
- Dimensão máxima da embalagem 260mm X 190mm
- Estampos customizados a pedido do cliente
- Barra de soldagem em alumínio teflonado
- Largura máxima da embalagem plástica 200 mm

Opcionais:

- Cubas Disponíveis
- mm 137x95 h.63
- mm 190x137 h.72
- mm 230x190 h.65
- mm 260x190 h.65
- Disponibilidade de estampos em relação as cubas disponíveis.



											
	watt	1ph	mm	mm	mm	mm	mm	mm	kg	mm	kg
Sigix M20	900	1ph	200	260x190	257	525	306	496	18	620x380x400	22

