

# RAVIOMATIC

máquina elétrica para ravioli

- Máquina elétrica para ravioli extrudados em massa folhada única
- Prática, flexível e veloz
- Disponíveis em diversos moldes por formato e dimensão
- Higienização facilitada pela simplicidade em desmontar cada componente em contato com o produto
- Regulagem da quantidade de recheio através de um sistema muito prático
- Motorizada com variação de velocidade em modo independente, permitindo sua adaptação à qualquer máquina de alto rendimento

## Opcionais:

- Disponibilidade de moldes de extrusão para diferentes espessuras de massa folhada entre 0,8 mm e 1 mm
- Kit conector entre a máquina de ravioli e a máquina de massas
- Suporte prático com um segundo funil de carregamento de recheio



Retangular pequeno serrilhado	Retangular grande serrilhado	Meia lua pequeno serrilhado	Meia lua grande serrilhado	Quadrado Serrilhado	Schlutzkrapfen meia lua liso	Triangular serrilhado
						
mm 50x42	mm 70x50	mm 50x31	mm 72x49	mm 37x37	mm 50x31 mm 72x49	mm 60x60

Moldes ravioli opcionais



Moldes ravioli intercambiáveis opcionais



Kit de conexão para Sirpasta XP e Concerto 5 opcionais









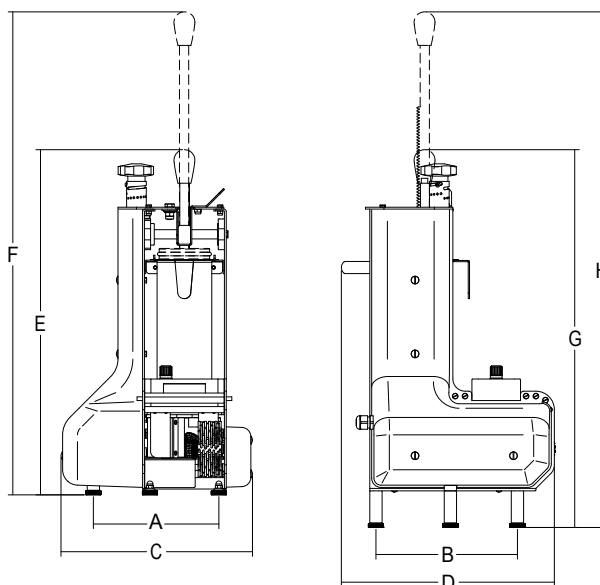





Kit de conexão para Orchestra 10 e Sirpasta Maxi opcionais



Segundo cilindro com suporte opcional



													
	watt	1ph	mm	mm	mm	mm	mm	mm	mm	mm	kg	mm	kg
<b>Raviomatic</b>	100	1ph	204	230	311	346	561	785	614	838	20	-	-